

# HPM8series Intelligent Pressure/Differential Pressure Transmitters Operation Manual (V5. 1)



- HPM81 differential pressure transmitter
- HPM82 differential pressure transmitter
- HPM84 input pressure transmitter
- HPM85 diaphragm seal type differential pressure transmitter
- HPM86 pressure transmitter
- HPM87 flanged diaphragm type pressure transmitter
- HPM88 pressure transmitter
- HPM89 pressure transmitter



## PREFACE

Dear Users:

Thank you for using the HPM8 series intelligent pressure transmitter.

This manual provides you with the basic operating steps for the installation and wiring of the HPM8 series intelligent pressure transmitter.

Before the instrument is put into operation, you need to read this manual in detail and correctly master the usage method before performing specific operations to avoid unnecessary losses caused by incorrect operations.

### 1. Warranty Description:

- The warranty period of this product is one year, the specific warranty period published on the website shall prevail.
- If there is no quality problem, we will not provide you with return and exchange service.

2. Under one of the following circumstances, no matter whether it is within the warranty period, there is no free warranty;

- The surface is corroded, cracked or concave and convex caused by human and damaged due to improper installation, use or maintenance.
- The delivery period of the product exceeds the warranty period.
- Those repaired by unauthorized service providers or technicians or disassembled and installed by users themselves.

3. The Company reserves the right to the final interpretation and change of the terms of service.

## Version Description:

This manual should be delivered to the end user in time.

All rights reserved. No part of this manual may be reproduced in any form without the written permission of manufacturer.

- ◆ The copyright belongs to the manufacturer. No part of this manual may be reproduced in any form without permission.
- ◆ The manufacturer may make necessary improvements and changes to this manual at any time for printing errors, inaccurate latest information, or improvements to programs or equipment without prior notice.
- ◆ The model specifications covered in this manual only apply to the standard model in the specification model, and not to the special order specification model.

## 1. Designated Uses

◆ The HPM8 series intelligent pressure transmitter is a kind of multi-function digital instrument, which adopts advanced MEMS technology, high purity monocrystic material, excellent suspension

structure, and combines with advanced intelligent SCM technology and sensor application technology to design carefully.

◆ The core components adopt high stability sensor chip, its excellent high precision, high stability, ultra high over-voltage performance, in the leading position in the world, thus ensuring the high quality of HPM8 series transmitters.

◆ The signal processing unit adopts 24-bit single chip microcomputer, whose powerful function and high-speed computing ability guarantee the excellent quality of HPM8 series intelligent transmitters. The whole design framework focuses on reliability, stability, high precision and intelligence.

◆ With powerful interface operation function, man-machine interaction. LCD with backlight display Digital watch head can display pressure, percentage and current, and 0~100% analog indication. Through key combination operation can achieve zero and full function, as well as data recovery function, greatly facilitate the field debugging.

◆ Integrated special integrated circuit (ASICs) is adopted for signal conversion, signal acquisition and processing and current output control to make HPM8 series intelligent transmitters with high stability, high reliability, high seismic characteristics, and good interchangeability.

◆ Standard international HART protocol, convenient for users to debug and network in various ways, unique wireless debugging module, mobile APP online functions, to achieve convenient remote debugging.

## 2. Safe Use

To ensure the safety of operators and instruments and systems, please read the instructions carefully and operate in strict accordance with the safety rules.

The company is not responsible for any loss caused by users' violation of operating rules. Please read the following notes carefully.

### 2.1 installation

The instrument shall be installed by special engineers or technicians. The work described in the "Installation" section is not allowed to be performed by an operator.

- ◆ If the working liquid is in high temperature, be careful to avoid scald.
- ◆ The instrument in use in the process is under pressure. Do not loosen the process joint bolts to avoid the dangerous injection of the process liquid.

- ◆ Be careful not to touch the skin, eyes and body or inhale steam when discharging residues from the pressure measuring part. The residual process fluid may be toxic or harmful.

- ◆ When removing the instrument from the hazardous process, avoid contact with the fluid and the inside of the instrument.

- ◆ All installations conform to site installation requirements and electrical code.

#### 2.2 wiring

- ◆ The instrument shall be installed by special engineers and technicians. The work described in the section "Wiring" is not allowed to be performed by an operator.

- ◆ Please confirm the voltage before the instrument and power supply and ensure that the power supply is not powered on when wiring.

#### 2.3 operating

- ◆ After power off, wait 5 minutes before opening the lid.

#### 2.4 maintenance

- ◆ Please do not carry out maintenance items other than the maintenance description. If the additional content is necessary, please consult with our company.

- ◆ During maintenance, care shall be taken to avoid structural changes, dust and foreign matter remaining on the display glass and nameplate. Use soft and dry cloth for maintenance.

#### 2.5 change

The company is not responsible for the fault or damage caused by the change of the instrument.

### 3. The quality assurance

The warranty period is the period specified in the quotation when purchasing. In principle, free repairs are provided if a fault occurs during the warranty period.

- ◆ When a fault occurs, the user can contact the instrument seller.

- ◆ When a fault occurs, please inform the fault phenomenon and the bad conditions when the fault occurs, including the model specifications and serial number. Any schematic diagrams, data and other information in the contact are very helpful.

- ◆ The party responsible for the repair cost shall be determined by the manufacturer after investigation.

- ◆ When a fault occurs due to the following reasons, the user shall bear the repair costs even during the warranty period.

- Incorrect or inappropriate repair by the user.

- Failure or damage caused by improper operation, use or storage beyond the design requirements.

- The place where the product is used does not conform to the standards specified by the manufacturer or due to improper maintenance at the installation site.

- Failure or damage caused by changes or repairs made by non-manufacturer or non-manufacturer designated maintenance units.

- Failure or damage caused by incorrect installation of the instrument.

- Damage caused by natural forces, such as fire, earthquake, interference, riot, war or radioactive contamination

# Contents



<b>Text information</b> .....	<b>- 5 -</b>
1. 1 Function of the document .....	- 5 -
<b>Basic safety guide</b> .....	<b>- 6 -</b>
2. 1 Person .....	- 6 -
2.2 Designated Use .....	- 6 -
2.3 Workplace safety .....	- 6 -
2.4 Operation Safety .....	- 6 -
2.5 Danger zone .....	- 6 -
2.6 Product Safety .....	- 6 -
2.7 Functional Safety (optional) .....	- 7 -
<b>Product performance description</b> .....	<b>- 7 -</b>
3. 1 Characteristics .....	- 7 -
3.2 Specification .....	- 7 -
3.3 Figure size .....	- 11 -
<b>The installation pack</b> .....	<b>- 13 -</b>
4. 1 General Installation Guide .....	- 13 -
4.2 Field installation .....	- 13 -
4.3 Installation location .....	- 15 -
4.4 Installation in dangerous places .....	- 15 -
4.6 Measurement method .....	- 17 -
<b>Wiring</b> .....	<b>- 19 -</b>
5.1 Connecting equipment .....	- 19 -
5.2 Wiring method .....	- 19 -
<b>Debugging</b> .....	<b>- 20 -</b>
6.1 Key location and LCD display .....	- 20 -
6.2 Keys operation .....	- 21 -
<b>Transmitter maintenance and fault handling</b> .....	<b>- 21 -</b>
7.1 Instrument maintenance .....	- 21 -
7.2 Troubleshooting .....	- 22 -
7.3 Display error code .....	- 22 -

## Text information







### 1.1 Function of the document

The documentation contains all the information needed at different stages of the equipment life cycle: from product identification, arrival acceptance and storage, to installation, electrical connection and debugging, as well as troubleshooting, maintenance and obsolescence.

### 1.2 Icon

 dangerous	<p><b>Danger!</b> Warning icon for dangerous conditions. Negligence can result in serious or fatal injury to a person.</p>
 Warning	<p><b>Warning!</b> Warning icon for dangerous conditions. Negligence can result in serious or fatal injury to a person.</p>
 Be careful	<p><b>Be careful!</b> Warning icon for dangerous conditions. Negligence can result in serious or fatal injury to a person.</p>
Pay attention to	<p><b>Attention!</b> Action and other influence prompt ICONS. Does not cause personal injury.</p>

### 1.3 Electrical Icon

icon	instructions	icon	instructions
	Direct current (dc)		Alternating current (ac)
	Direct current (dc) and Alternating current (ac)		<p>Grounding connection The operator defaults that the grounding terminal has passed The grounding system is reliably grounded.</p>
	Protective ground connection Prior to subsequent electrical connections, the terminal must be safely and reliably grounded		<p>Equipotential connection Must be connected to the factory grounding system: Use an equipotential cable or use a star The grounding system is connected, depending on the national standard Standard or company specification</p>

## Basic safety guide

### 2.1 Person

Personnel performing installation, commissioning, diagnosis and maintenance operations must meet the following requirements:

Qualified professionals who have been trained must be qualified to perform specific operations and tasks

Be familiar with league/national laws and regulations

◆ Prior to commencement of operation, professionals must read and understand the guidelines in this Instructions, supplementary documentation and certificates (rejected for application)

◆ Comply with the guidelines in this Instructions

### 2.2 Designated Use

HPM8 series pressure transmitters for pressure, flow and liquid level measurement.

◆ Wrong use

The manufacturer shall not be liable for any damage to the equipment caused by improper use or use for non-specified purposes. Verification of measuring conditions: we are happy to help you verify the corrosion resistance of the material of the liquid receiving parts when measuring special fluids and clean fluids, but we do not guarantee or assume any responsibility for this.

### 2.3 Workplace safety

When operating the equipment:

◆ Abide by the laws and regulations of the Federation/state, and wear protective devices.

◆ Before wiring the equipment, turn off the power.

### 2.4 Operation Safety

There is a risk of injury!

▲ Operating equipment only under correct technical conditions and guaranteed safety conditions.

▲ The operator is responsible for ensuring that the equipment is operated without interference.

Unauthorized modification of equipment is prohibited, which may cause unforeseeable risks:

▲ If you need to change, please consult the company's local sales center.  
repair

▲ Operation safety and reliability should be ensured.

▲ Only expressly permitted equipment:

▲ Only use the company's original spare parts and accessories.

### 2.5 Danger zone

When the equipment is used in the hazardous area, measures should be taken to eliminate the danger of personnel or equipment (e.g. explosion protection, pressure vessel safety) :

◆ Refer to the nameplate, check and confirm whether the ordered equipment is allowed to be used in the danger area.

◆ Comply with the provisions in the supplementary documents. The supplementary documents shall be an integral part of the Operation Manual.

### 2.6 Product Safety

The measuring equipment is designed based on engineering experience and meets the most advanced and stringent safety requirements. It passes the factory test and can be used safely. The measuring

equipment meets the routine safety requirements and legal requirements. It also meets the requirements of EC guidelines in the equipment EC conformance statement. The company ensures that the measuring equipment with THE CE mark conforms to this requirement.

### 2.7 Functional Safety (optional)

When using equipment in applications with overall safety requirements, the requirements of the Instructions must be fully complied with.

## Product performance description

### 3.1 Characteristics

#### (1) High accuracy

The monocrystalline silicon pressure transmitter can be used for high accuracy measurement within the rated measurement range.

Reference accuracy of standard calibration range:  $\pm 0.075\%$ ; reference accuracy of microrange standard calibration range: better than 0.1%.

Zero plus or minus transfer without linearity adjustment

#### (2) Excellent environmental adaptability

Intelligent static pressure compensation and temperature compensation protect the transmitter from the influence of temperature, static pressure and overpressure

Error control to the minimum.

#### (3) Flexible range compression

M1 cartridge range ratio: 40:1;

Range ratio of M2 capsule, M3 capsule, M4 capsule, L1 capsule: 100:1

Range ratio of S1 and S2 capsule: 10:1

#### (4) Excellent operability and ease of use

- ◆ It has a 5-digit LCD digital display with backlight
  - ◆ Various display functions (Pa, kPa, MPa, BAR, MBar, %, PSI, mmH<sub>2</sub>O)
  - ◆ Built-in three-button quick operation local adjustment function
- Equipped with a variety of anti - corrosion materials
- ◆ Comprehensive self-diagnosis functional product performance description

#### (5) Flameproof certification Ex D IIC T6 and Ben An Ex IA IIC T4

#### (6) CE certification for all products

### 3.2 Specification

- ◆ Measured flow: liquid, gas, vapor
- ◆ Measurement scope:

HPM81 Differential pressure transmitter:

range	KPa	mbar	Unilateral over pressure	Bilateral over pressure
M1	- 40 ~ 40	- 400 ~ 400	10MPa	25MPa
M2	- 100 ~ 100	- 1000 ~ 1000	10MPa	25MPa
M3	- 200 ~ 200	- 2000 ~ 2000	10MPa	25MPa



M4	- 400 ~ 400	- 4000 ~ 4000	10MPa	25MPa
L1	- 4000 ~ 4000	- 40000 ~ 40000	10MPa	25MPa

HPM82 differential pressure transmitter

Range/range		KPa	mbar	mmH <sub>2</sub> O	Unilateral over pressure	Bilateral over pressure
S1	range	0.1 ~ 1	1 ~ 10	10 to 100	2MPa	10MPa
	The scope of	1 ~ 1	- 10-10	- 100 ~ 100		
S2	range	0.2 ~ 6	2 ~ 60	20 ~ 600	3MPa	25MPa
	The scope of	- 6 ~ 6	- 60 ~ 60	- 600 ~ 600		

HPM84 input pressure transmitter

range	KPa	mH <sub>2</sub> O	Maximum working pressure
L1	0 ~ 1000	0 ~ 100	Range of 1.5 times

HPM85 diaphragm seal differential pressure transmitter

KPa	mbar	Unilateral over pressure	Bilateral over pressure
- 40 ~ 40	- 400 ~ 400	10MPa	25MPa
- 100 ~ 100	- 1000 ~ 1000	10MPa	25MPa
- 200 ~ 200	- 2000 ~ 2000	10MPa	25MPa
- 400 ~ 400	- 4000 ~ 4000	10MPa	25MPa
- 4000 ~ 4000	- 40000 ~ 40000	10MPa	25MPa

HPM86 pressure transmitter

range	KPa	mbar	Maximum working pressure
S1	1 ~ 1	- 10-10	2MPa
S2	- 6 ~ 6	- 60 ~ 60	3MPa
M1	- 40 ~ 40	- 400 ~ 400	3MPa
M2	- 100 ~ 100	- 1000 ~ 1000	10MPa
M3	- 100 ~ 200	- 1000 ~ 2000	10MPa
M4	- 100 ~ 400	- 1000 ~ 4000	10MPa
L1	- 100 ~ 4000	- 1000 ~ 40000	10MPa
L2	- 100 ~ 40000	- 1000 ~ 400000	60MPa

HPM87 flanged diaphragm type pressure transmitter

range	KPa	mbar	Maximum working pressure
M1	- 40 ~ 40	- 400 ~ 400	3MPa
M2	- 100 ~ 100	- 1000 ~ 1000	10MPa
M3	- 100 ~ 200	- 1000 ~ 2000	10MPa
M4	- 100 ~ 400	- 1000 ~ 4000	10MPa
L1	- 100 ~ 4000	- 1000 ~ 40000	10MPa

HPM89 pressure transmitter

range	KPa	Maximum working pressure
L1	-100 ~ 0 ~ 100000	Range of 1.5 times

HPM88 pressure transmitter

range	KPa	Maximum working pressure
L1	- 100 ~ 70000	50 ~ 100 times full range pressure

◆ Output signal : 4 ~ 20mA+HART protocol

Allow the load resistance: 0 ~ 600 Ω (24VDC)

Note: communication with handheld communication device, need standard (250 Ω) load resistance.

Power source:

General purpose	DC10.5 ~ 45 v
Intrinsically safe explosion-proof	DC10.5 ~ 26 v

Communication line conditions: Line length: maximum 2km

(0.75 ~ 1.25 mm<sup>2</sup> Cable for control instrument, double stranded cable for more than 1km)

Load resistance: 250 ~ 600 Ω (DC 24 v, including cable resistance)

Load capacity: 0.55mF below load susceptance: 3.3mH below

Spacing of power lines: above 15cm (please avoid parallel wiring)

◆ Saturation current: upper limit 20.8mA lower limit 3.8mA

◆ Alarm current: Upper limit: 22.8mA lower limit: 3.6mA (adjustable mode)

◆ Adjusting power: Zero and full range points can be adjusted in place by pressing three buttons on the top of the shell or can be adjusted remotely by using configuration software

◆ Zero-point transfer: it can be moved within the range of -20% to + 20% of the maximum range

◆ Output formula: linear output square root output (which can be adjusted remotely by configuration software)

◆ Environmental temperature: -40~+85℃ (normal) ; -20~+60℃ (explosion-proof); -10~+60℃ (when filled with fluorine oil)

◆ Storage temperature: -40~+90℃

- ◆ Weather resistance: DIN40040GPC
- ◆ EMC application standard: EN 1326-1:2006
- ◆ Square root output accuracy:

The output	precision
50% or higher	Coreference accuracy
50% ~ drop point	Reference accuracy x 50 Square root output (%)

- ◆ Influence of ambient temperature: Total amount of influence /28 °C (50 ° F)

model	range	Reference accuracy
HPM81	M1, M2 and M3	± [0.08% range + 0.015% upper range]
	The M4, L1	± [0.08% range + 0.03% upper range]
HPM82	S1	± [0.08% range + 0.09% upper range]
	S2	± [0.07% range + 0.02% upper range]
HPM85	M1, M2 and M3	± [0.08% range + 0.015% upper range]
	The M4, L1	± [0.08% range + 0.03% upper range]
HPM86	S1, S2, M1, M2, M3 and M4	± [0.08% range + 0.015% upper range]
	L1, L2,	± [0.08% range + 0.03% upper range]
HPM87	M1, M2 and M3	± [0.08% range + 0.015% upper range]
	The M4, L1	± [0.08% range + 0.03% upper range]
HPM84	L1	±0.03%FS/°C (reference: 25 °C)
HPM89	L1	±0.03%FS/°C (reference: 25 °C)

- ◆ Overpressure noise:  
± 0.05% upper range /10MPa (Note: 1.5 times of overload range of HPM84 and HPM89)

- ◆ Stability:

HPM81 / HPM85 / HPM86 / HPM87 / HPM84 / HPM89: + / - 0.05% range limit / 12 months

HPM82: ± 0.1% upper range /12 months

- ◆ Power impact: ± 0.005% /1V

◆ Influence of installation position: The change of installation position parallel to the film one-sided will not cause zero drift. If the change of installation position and film one-sided exceeds 90°, it can be corrected by adjusting zero.

- ◆ Response time: 90ms

- ◆ Damping: The time constant can be adjusted in 0~99.9 seconds

- ◆ filter constant: adjustable from 0 to 160uA

- ◆ Self-stabilizing system number: Adjustable within 0~2%

### 3.3 Figure size

Differential pressure transmitter HPM81/HPM82

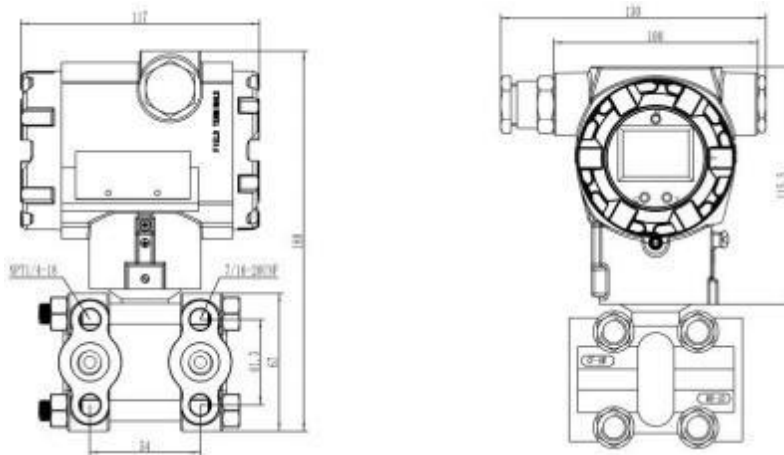

HPM86/HPM88/HPM89 Pressure transmitter

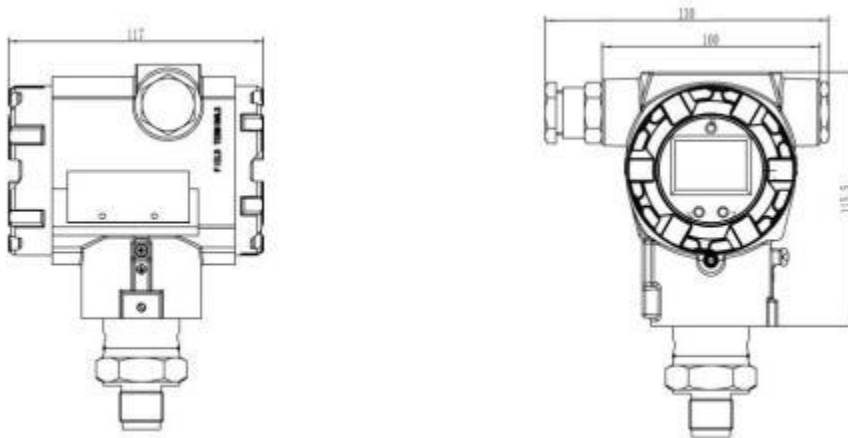

HPM84 Submerged pressure transmitter

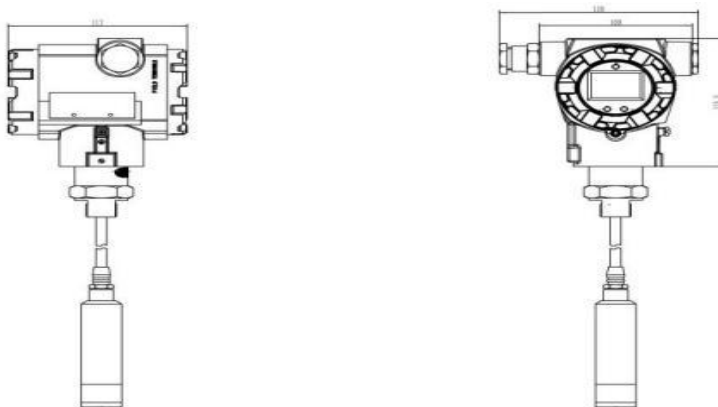

HPM85 diaphragm seal type differential pressure transmitter

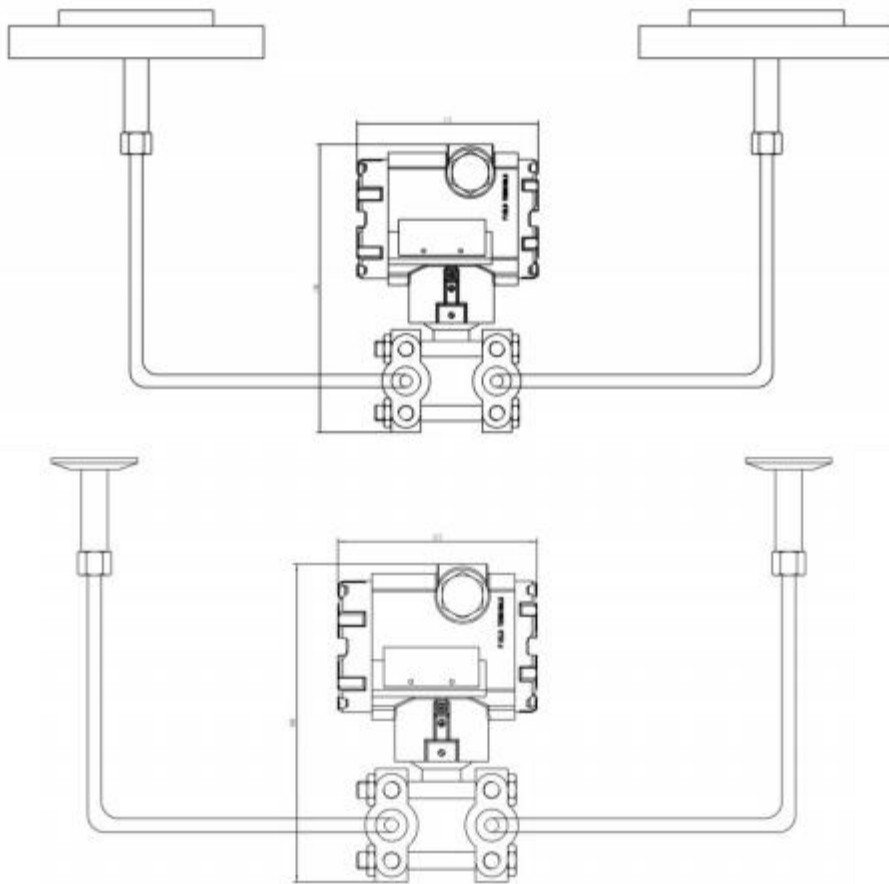

HPM87 flanged diaphragm type pressure transmitter

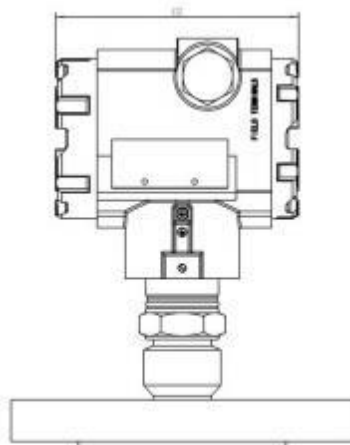

# The installation pack

## 4.1 General Installation Guide

- ◆ HPM8 series installation may result in measurement deviation. For example, when measuring in an empty container, the measured value displayed is not 0. At this time, zero migration correction can be carried out through local three-button or remote operation.
  - ◆ Please refer to DIN 19210 standard "Fluid measurement method" for general installation requirements of pressure removal pipe; Differential pressure pipeline of flow measurement equipment", relevant national or international standard. Without interrupting the process, it is easy to debug, install and maintain the instrument by using three or five valve sets.
  - ◆ Adequate anti-freezing protection measures should be taken when installing the pressure-taking pipe outdoors, such as heat tracing of pipe.
- The inclined installation Angle of the compression line shall be at least 10%.
- ◆ Do not use hard or sharp objects to clean or contact the diaphragm seal ring.
  - ◆ The maximum rotation Angle of the case is 360° to ensure the best readability of the field display unit.
  - ◆ The field display screen can be rotated 90° .
  - ◆ The company provides instrument mounting bracket.

## 4.2 Field installation

The intelligent transmitter manufactured by our company can be installed on horizontal or vertical pipes through different mounting brackets. The following figure shows the different types of installation

### u Differential pressure transmitter installation(optional)

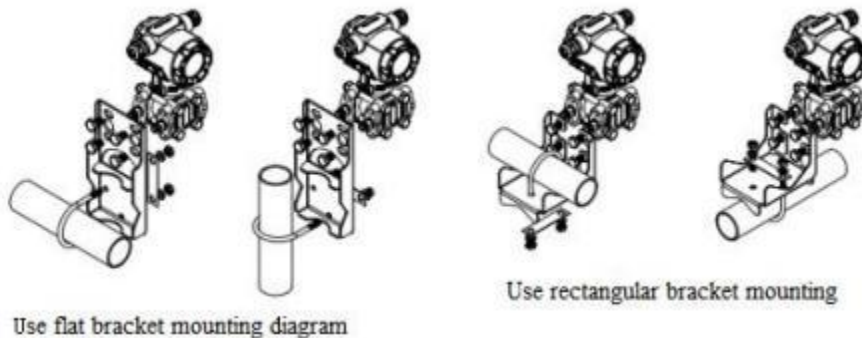

### u Pressure transmitter installation

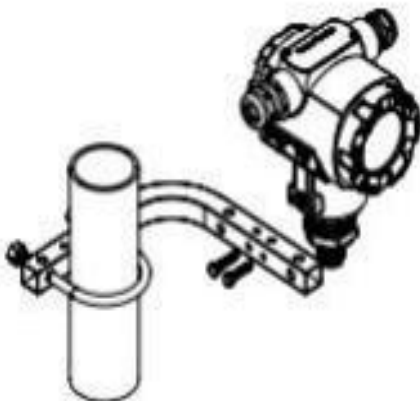

Use L bracket installation drawing  
u Submerged transmitter installation

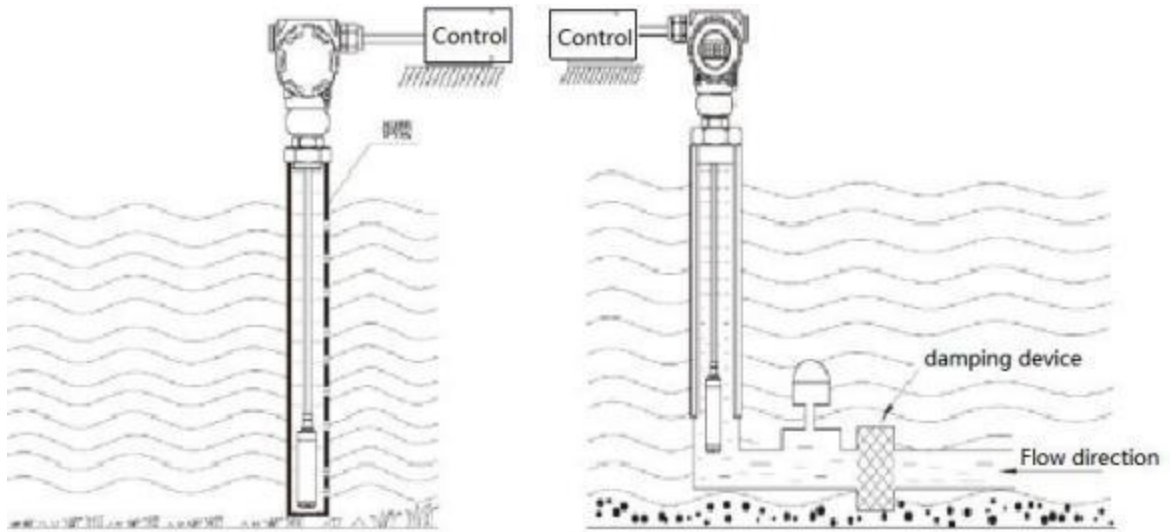

**Dynamic water installation**

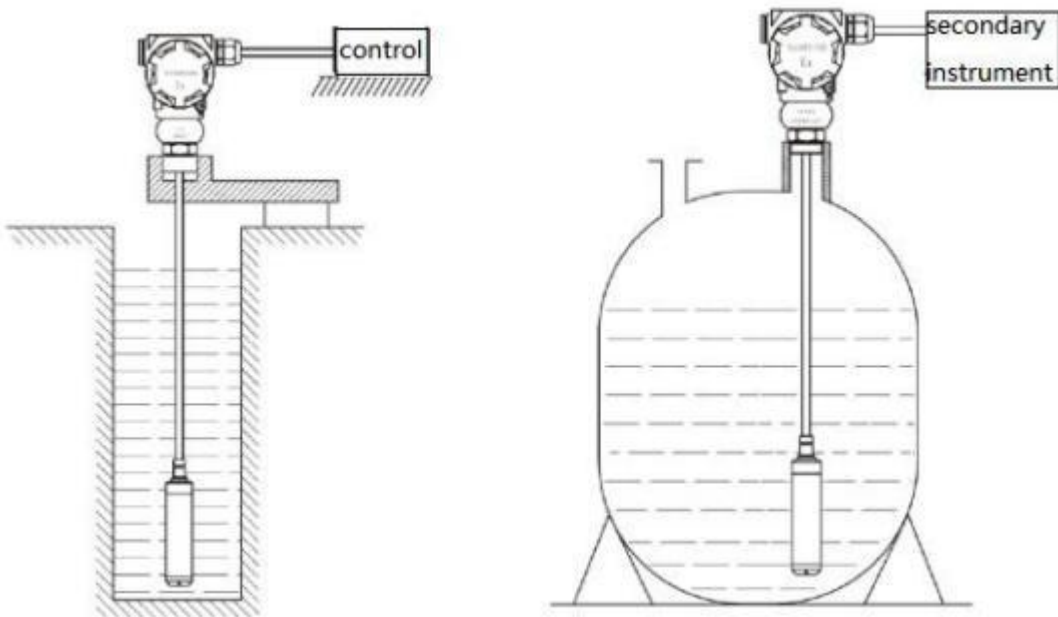

**Hydrostatic installation**

### 4.3 Installation location

The correct position of the transmitter in the process pipe depends on the measured medium. For optimal installation, please consider the following:

- ◆ Prevent transmitter from contacting corrosive or overheated medium.
- ◆ To prevent sediment deposition in the pressure tube.
- u The guide tube should be as short as possible.
- u The liquid column head in the pressure guide tube on both sides should be balanced.
- u The pressure guide tube should be installed in the place with small temperature gradient and temperature fluctuation.
- ◆ Prevent crystallization or freezing at low temperature in pressure injection tube.

### 4.4 Installation in dangerous places

In dangerous places must use Intelligent explosion-proof transmitters. Intelligent explosion-proof transmitters are the extension products of intelligent transmitters. The working principle and basic structure are the same as the intelligent transmitter.

There are two kinds of intelligent explosion-proof transmitter: intrinsically safe type and flameproof type. The flameproof type and intrinsically safe type instrument accord to Gb3836.1-2000 General Requirements for Explosion-proof Electrical Equipment used in Explosive Environments.

The inner shell of the explosion-proof intelligent transducer can withstand the explosion, and the internal explosion does not cause the explosion of the explosive mixture specified by the outside. Its mark is D, which conforms to the provisions of GB3836.2-2000 "Explosion-proof Electrical Equipment for Explosive Environment flameproof electrical Equipment" D ", and its explosion-proof grade is ExdIIC T6.

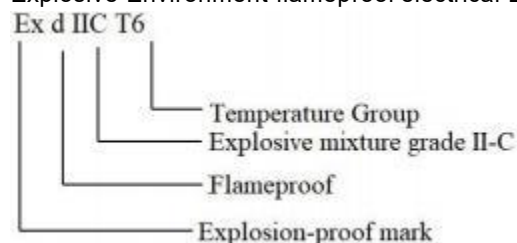

Intelligent transmitter intrinsically safe type: refers to the circuit system, in normal operation or specified fault state, the point spark and thermal effect can not ignite the specified explosive mixture, marked as IA in accordance with GB38364-2000 "Electrical Equipment used in explosive gas environment essential safety type" I "provisions, explosion-proof grade is ExiaIIC T4. The transmitter and the safety grid of associated equipment installed in the control room are used together to form an intrinsically safe explosion-proof system.

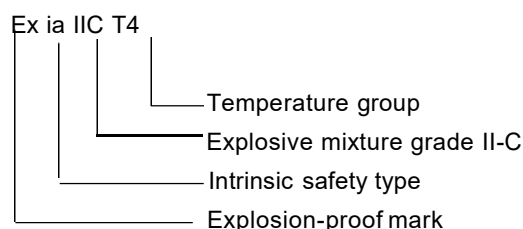



Flameproof structure:

All electrical components and circuit boards of explosion-proof intelligent transmitters are placed in the explosion-proof housing. The transmitter housing has sufficient mechanical strength and flameproof performance even if the spark internal explosion is caused by instrument failure. Not only will not damage the flameproof shell, but also can not cause the explosive mixture outside the shell to explode.

#### 4.5 Precautions for users using explosion-proof transmitter

The explosion-proof products of intelligent transmitter have been inspected by national instrument and instrument explosion-proof safety supervision and Inspection Station (NEPSI), and are in conformity with the requirements to GB3836.1-2000, GB3836.2-2000 and GB3836.4-2000, the flameproof marks of the products are ExdIICT6 (excluding acetylene) and ExiaIICT4; Users should pay attention to the following matters when using the products:

- ◆ The transmitter housing shall be reliably grounded when in use;
- ◆ The ambient temperature range of explosion-proof products is  $-20^{\circ}\text{C} \sim +60^{\circ}\text{C}$ ;
- ◆ When the flameproof product is in use and maintenance, must follow the principle "open the cover after power supply is cut off";
- ◆ When the intrinsically safe product is installed and used on site, it must be connected with the safety grid LB987S, MTL787S, E787 etc. Which certified by the explosion-proof inspection institution to form the intrinsically safe and explosion-proof system. If it wants to be matched with other safety grids, it must be approved by the explosion-proof inspection institution;
- u The connection cable between the transmitter and the safety grid base end is a two-core shielded cable (the cable must have a cable sheath). The core wire has a cross-sectional area  $\geq 0.5\text{mm}^2$ , and its shielding layer is single-ended ground in a safe place and insulated from the product shell; The influence of electromagnetic interference should be eliminated as far as possible and the cable distribution parameter should be controlled within  $0.06\text{ F/1mH}$ .
- ◆ Safety grid shall be installed in a safe place, and its installation, use and maintenance must follow the safety grid operation manual.
- u The user is not allowed to change the electrical components and system connection state of the product at will.
- ◆ The products' installation, use and maintenance shall be in accordance with the product operation instructions, GB3806.15-2000 "Electrical equipment for explosive gas environment - Part 15: Electrical installation in dangerous places (except coal mines)" and GB50058-1992 "Design Code for Electrical Installations in Explosive and fire dangerous Environments".
- u The introduction cable of the flameproof product should conform to  $8 \sim 8.5\text{mm}$ . Tighten the compression nut to make the sealing ring tightly cling to the cable for site use.
- ◆ If the product has redundant inlet, we must use the plug provided by our company to plug it.
- ◆ The front and rear covers of the product are respectively designed with anti-loosing screws. Make sure that the anti-loosing screws and the front and rear covers are tightly secured to ensure the lid is anti-loosing.

#### 4.6 Measurement method

##### ◆ Liquid measurement:

When measuring liquid flow rate, the pressure outlet should be opened on the side of the flow line to avoid sediment precipitation. At the same time the transmitter must be installed

It is installed next to or below the pressure outlet so that bubbles can be discharged into the flow pipe.

◆ Gas measurement: When measuring gas flow rate, the pressure outlet should be opened on the top or side of the flow pipeline. And the transmitter should be installed next to or above the process pipe so that accumulated liquid can easily flow into the process pipe.

##### ◆ Steam measurement:

When measuring steam flow, the pressure outlet is opened on the side of the flow line and the transmitter is installed below the pressure outlet so that the condensate can fill the guide pipe. It should be noted that when measuring steam or other high temperature media, the temperature should not exceed the transmitter operating limit temperature. When the measured medium is steam, the guide tube should be

filled with water to prevent the steam from coming into direct contact with the transmitter, since the volume variation of the transmitter during operation is negligible and no condensing tank is required.

Note: use a pressure chamber transmitter equipped with a relief valve. The pressure outlet should be opened on the side of the flow line. When the measured medium is liquid, the discharge valve of the transmitter shall be installed above in order to discharge the gas permeated in the measured medium. When the measured medium is a gas,

The drain valve of the transmitter shall be installed below to discharge the accumulated liquid.

◆ Liquid level measurement: The differential pressure transmitter used to measure the liquid level is actually the static pressure head of the liquid column. This pressure is made up of liquid

Determined by the height of bit and specific gravity of liquid, its size is equal to the height of liquid level above the pressure port multiplied by the specific gravity of liquid, and

The size or shape of the container is independent.

##### (a) Liquid level measurement in open containers

When measuring the liquid level of an open container, the transmitter is mounted near the bottom of the container to measure the pressure corresponding to the liquid level above it. The pressure of the tank level is connected to the high pressure side of the transmitter and the low pressure side to the atmosphere. If the measured level changes in the range of

At the lowest level above the transmitter installation, the transmitter must be positively migrated.

##### (b) Liquid level measurement in closed containers

In an airtight container, the pressure of the container above the liquid affects the pressure measured at the bottom of the container. So the pressure at the bottom of the container

Force is equal to the height of the liquid times the specific gravity of the liquid plus the pressure of the containment. To determine the true liquid level, subtract the pressure of the container from the pressure measured at the bottom of the container. For this purpose, a pressure outlet is opened at the top of the container and connected to the low-pressure side of the transmitter, so that the pressure in the container ACTS simultaneously on the high-low side of the transmitter. The resulting differential pressure is proportional to the product of the height of the liquid and the specific gravity of the liquid.

◆ Dry conduction connection If the gas above the liquid does not condense, the connection tube on the low pressure side of the transmitter will remain dry. This situation is called dry conduction connection. The method for determining the measuring range of the transmitter is the same as that for the liquid level of the open container.

◆ If the gas above the liquid condenses, the liquid will gradually accumulate in the pressure guide tube on the low pressure side of the transmitter, which will cause the measurement error. To eliminate this error, a liquid is pre-filled into the low pressure side guide tube of the transmitter, a situation known as a wet guide connection.

(c) Reduction of errors

The pressure guide pipe connects the transmitter to the process pipe and transmits the pressure from the pressure outlet on the process pipe to the transmitter.

In the process of pressure transmission, the possible causes of errors are as follows: Leakage in pieces;

- ◆ Wear loss (especially when cleaning agent is used);
- ◆ There is gas in the liquid pipeline (causing pressure head error);
- ◆ Liquid storage in gas pipeline (causing pressure head error);
- ◆ Difference in density caused by temperature difference between two sides of the guide pressure tube (resulting in pressure head error).

(d) Error reduction can be achieved by:

- ◆ The pressure guide tube should be as short as possible;
- ◆ When measuring liquid or steam, the pressure guide pipe should be connected upward to the process pipe with a degree of inclination not less than 1/12;
- ◆ For gas measurement, the pressure guide pipe should be connected downward to the process pipeline with a slope of no less than 1/12;
- ◆ The arrangement of the liquid pressure guide pipe should avoid the high point in the middle, and the arrangement of the gas pressure guide pipe should avoid the low point in the middle;
- ◆ The two pressure pipes should keep the same temperature;
- ◆ To avoid friction, the diameter of the pressure guide pipe should be large enough;
- ◆ There should be no gas in the pressure guide tube filled with liquid;
- ◆ When isolating liquid is used, the liquid in the pressure guide tube on both sides should be the same;

## Wiring

### 5.1 Connecting equipment

#### Warning

Risk of electric shock! When the working voltage is higher than 35V DC: the terminal is equipped with dangerous voltage.

▲ Do not open the shell cover in damp environment. Connection error can result in limited electrical safety!

▲ There is a risk of electric shock/explosion in the danger zone!

▲ When using measuring equipment in dangerous areas, it is necessary to comply with relevant national standards and regulations, as well as "Safety Guide" or "Installation/Control Icon" for installation.

▲ Equipment with built-in overvoltage protection unit must be grounded.

▲ With polarity reverse connection, radio frequency interference (HF), peak overvoltage protection circuit.

### 5.2 Wiring method

#### 5.2.1 the wiring diagram

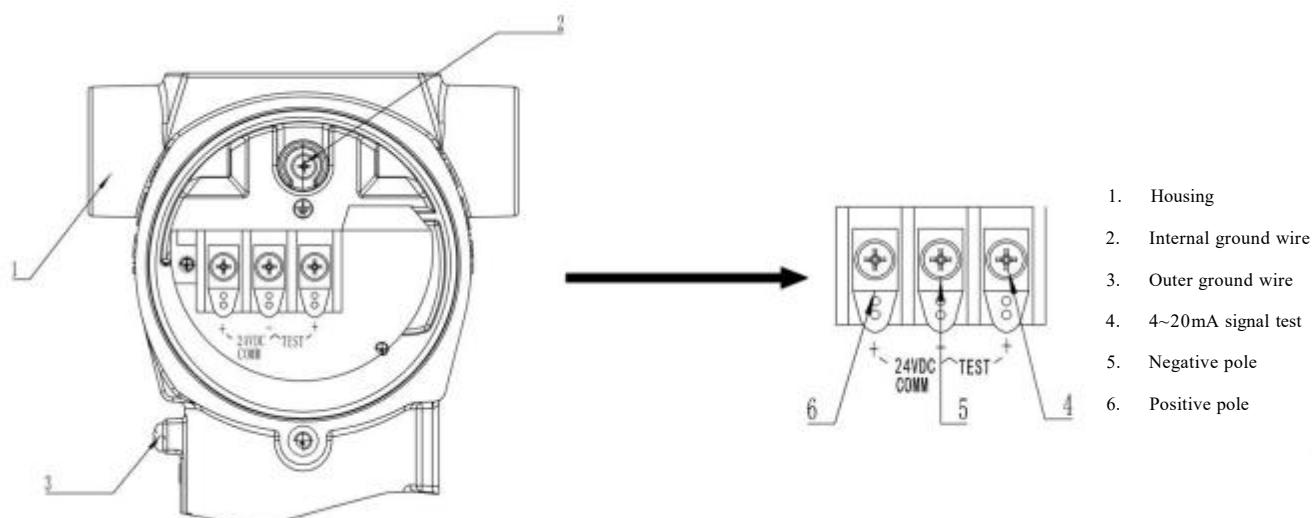

#### 5.2.2 Cable specifications

The company recommends the use of shielded, double - core double - stranded cable. The cross-sectional area of wiring terminal core: 0.5~2.5 mm squared

◆ Cable diameter: 5~ 9mm

#### 5.2.3 Shielding/potential balance

◆ The best shielding effect is achieved when the shield is grounded at both ends (to the control and the device, respectively) to prevent interference from affecting the measurement. In the case of strong equalizing currents in the plant, the shield is only connected at one end, and it is recommended to ground it at the transmitter..

◆ When used in hazardous areas, the applicable regulations must be observed. Additional technical data and operating instructions in a separate Ex manual are standard documentation for all Ex systems.

## Debugging

### 6.1 Key location and LCD display



(1) unlock by pressing the key <Z> and <S> for more than 5 seconds (LCD screen display: OPEN)

(2) PV value reset

Put the transmitter directly on the atmosphere, press the button to open the lock, press <Z> and <S> at the same time for more than 2 seconds, then the current PV value can be set to 0 (LCD screen display: PV=0), and then press <M> to return the measurement state.

Note: If the deviation between the current PV value and the 0 value exceeds 50%FS, the PV value is null and void. (LCD screen: PVER)

(3) Active migration at 4mA point

Zero setting: apply zero pressure to the transmitter, press <Z> key for 2 seconds, the transmitter output 4.000mA current, complete zero setting operation (LCD screen display: LSET)

(4) Active migration at 20mA point

Button full: Apply full pressure to the transmitter. Press the <S> key for 2 seconds, the transmitter outputs 20.000mA current to complete the zero adjustment operation (LCD screen displays HSET).

(5) Transmitter data recovery

First, press <Z> and continue to hold <Z> for more than 5 seconds after switching on the transmitter power. If the LCD screen shows OK, it indicates that the transmitter data has been restored to the factory state,

and then release the key. If the LCD displays FALL, it indicates that no data backup has been made to the transmitter and the transmitter data cannot be restored to the factory state.

Note: 1. The above (2), (3) and (4) functions need to be unlocked by pressing the button.

2. If no button is pressed within 2 minutes, the transmitter button will automatically open the lock.

## 6.2 Keys operation

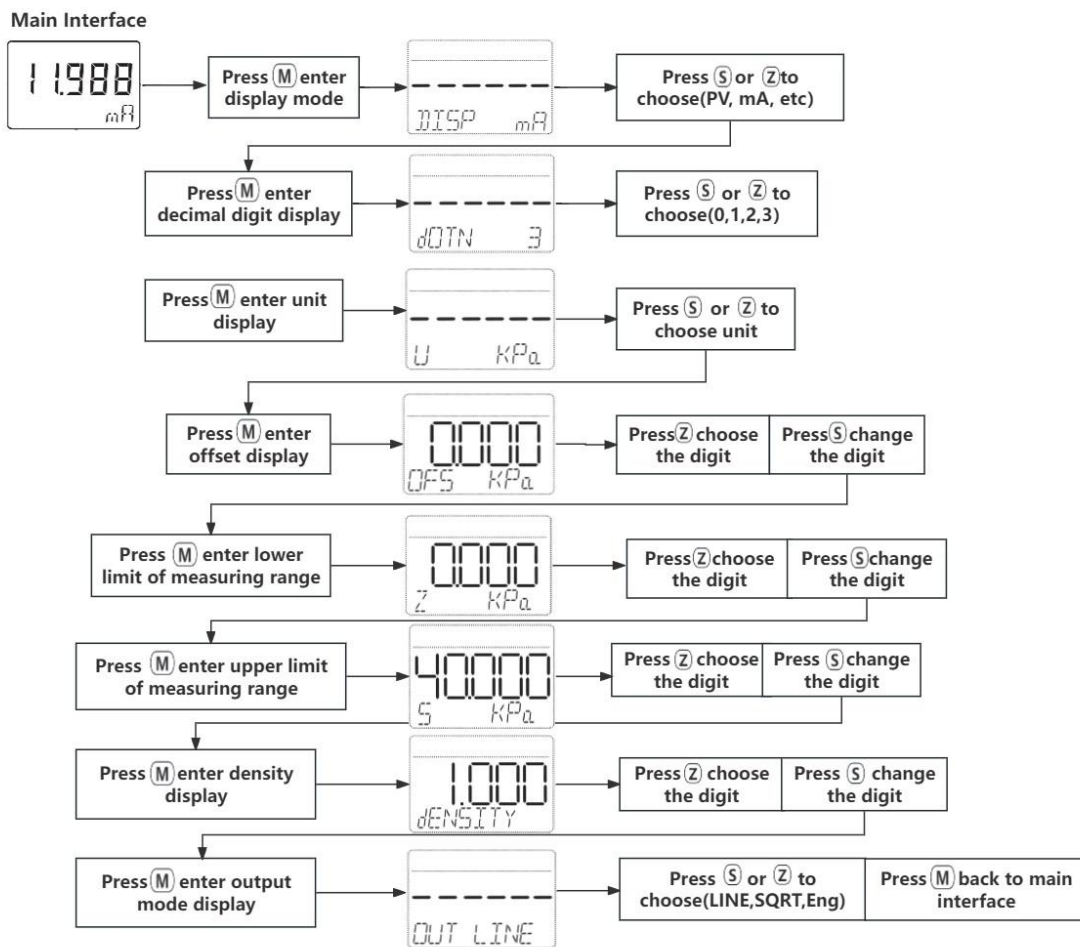

### PV Zero cleaning (Transmitter is at atmospheric pressure)

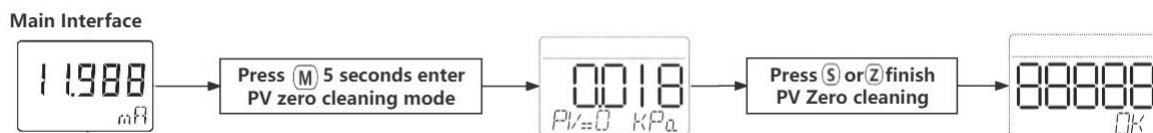

## Transmitter maintenance and fault handling

### 7. 1 Instrument maintenance

#### 7. 1. 1 soft maintenance

HART intelligent transmitter is an intelligent product, and its parameters are open to users, who can adjust the zero, set the range, set the damping, and even calibrate again according to the actual situation. When the core parameters are modified or confused, it will cause a soft failure. At this time, please refer to the previous section to debug and make it work normally.

When the actual situation needs to adjust zero again, please remove the cover of the shell and adjust with the key, or directly use the software for debugging. The specific adjustment method shall refer to the above key operation instructions and software debugging method.

#### 7. 1. 2 hard maintenance

Generally speaking, if the sensor module, main circuit board and watch head are not repairable on site, the user's hardware maintenance project is limited to circuit connection inspection, transmitter cleaning, replacement, and terminal terminal inspection.

◆ The following points should be noted in the ontology inspection of process sensor:

- (1) The transmitter should be removed from the working point before decomposing the sensor body.
- (2) Temperature and pressure cycling experiments must be carried out after reassembly to ensure the accuracy of the transmitter.
- (3) The pressure chamber can be removed by removing the four bolts.
- (4) The isolation diaphragm can be cleaned with a soft cloth and a flexible detergent and washed with clean water.
- (5) For ease of installation, the pressure chamber and joint may be installed by rotation or reverse.

◆ Check the wiring terminal. Unscrew the back cover and you can see the wiring terminal. Unscrew the two positioning screws and remove the terminal cover to see the circuit board. Can check whether the connection of wiring circuit board is correct, reliable. It is mainly focused on the assembly of core capacitors and test diodes.

### 7.2 Troubleshooting

In the case of transmitter failure, the following steps can help identify the cause of the problem. It can also help determine if it needs to be removed and repaired. These materials help to diagnose and repair the three basic symptoms of failure. For each symptom, first deal with the conditions that are easiest to check. If you cannot repair, please contact our service center.

### 7.3 Display error code



— Current not calibrated



— Sensor error



— Out of display range



— Not calibrate pressure

